

# Zertifikat

# Certificate



Zertifikat Nr. *Certificate No.*  
S 60151564

Blatt *Sheet*  
0001

Ihr Zeichen *Client Reference*

Unser Zeichen *Our Reference*  
0010--60360848 002

Längstens gültig bis  
09.09.2025

*Latest expiration date*  
(day/mo/yr)

Genehmigungsinhaber *License Holder*

Lista AG  
Fabrikstr. 1  
8586 Erlen  
Schweiz

Fertigungsstätte *Manufacturing Plant*

Lista AG  
Fabrikstr. 1  
8586 Erlen  
Schweiz

Prüfzeichen *Test Mark*



www.tuv.com  
ID 1111228830

Geprüft nach *Tested acc. to*

DIN 4548/10.16  
DIN 5054/12.19  
AfPS GS 2019:01 PAK

Zertifiziertes Produkt (Geräteidentifikation)  
*Certified Product (Product Identification)*

Lizenzentgelte - Einheit  
*License Fee - Unit*

Schrank / Schubladenschränke aus Stahl

Bezeichnung: Lista  
Schubladenschränke stationär und mobil,  
mit Flügel- oder Schiebetüren

17

Typen: siehe Anlage 1 zum Zertifikat

Material: Stahlblech DC01

Traglasten: Schubladen: 75 bzw. 200 kg  
Verstellboden: 200 kg

- stationäre Schubladenschränke mit Bodenverankerung

Ersetzt Zertifikat S 60094755\_0001 und \_0002

17

ANLAGE (Appendix): 1; Seite/page 1-21

Dem Zertifikat liegt unsere Prüf- und Zertifizierungsordnung zugrunde.  
Produkt und Fertigungsstätte erfüllen § 20 und § 21 des  
Produktsicherheitsgesetzes.

*This certificate is based on our Testing and Certification Regulation.  
Product and production fulfill par § 20 and § 21 of the  
Product Safety Law.*

TÜV Rheinland LGA Products GmbH, Tillystraße 2, 90431 Nürnberg

Tel.: +49 221 806-1371 e-mail: cert-validity@de.tuv.com  
Fax: +49 221 806-3935 http://www.tuv.com/safety

Ausstellungsdatum *Date of Issue* : 10.09.2020 (day/mo/yr)

Zertifizierungsstelle



# Anlage / Appendix 1 zu / to

Zertifikat / Certificate  
**60151564**

Blatt / Page  
**0001**

Ihr Zeichen / Client Reference

Unser Zeichen / Our Reference

Ausstellungsdatum / Date of issue

0010 - - 60360848 002

10.09.2020













## Schubladenschränke stationär und mobil

**18x27 E**

**B** → 411 mm

**T** ↗ 572 mm

 306 x 459 mm

	<b>H</b> ↑	Anzahl Schubladen mm			Art.-Nr. 
	283	2: 1x50/1x150	75	KEY Lock	78.400.XXX
	283	2: 2x100	75	KEY Lock	78.402.XXX
	283	3: 1x50 / 2x75	75	KEY Lock	78.404.XXX
	383	3: 1x50 / 1x100 / 1x150	75	KEY Lock	78.406.XXX
	383	3: 2x75 / 1x150	75	KEY Lock	78.408.XXX
	383	4: 1x50 / 2x75 / 1x100	75	KEY Lock	78.410.XXX
	533	4: 1x50 / 1x100 / 2x150	75	KEY Lock	78.414.XXX
	700	3: 1x100 / 1x200 / 1x300	75	KEY Lock	78.418.XXX
	700	5: 2x75 / 3x150	75	KEY Lock	78.420.XXX
	723	4: 1x50 / 1x100 / 2x150	75	KEY Lock	78.423.XXX
	723	5: 2x50 / 2x100 / 1x150	75	KEY Lock	78.425.XXX
	840	6: 2x50 / 2x75 / 2x150	75	KEY Lock	78.427.XXX

**Anlage / Appendix 1 zu / to**
**Zertifikat / Certificate**
**Blatt / Page**
**60151564**
**0001**
**Ihr Zeichen / Client Reference**
**Unser Zeichen / Our Reference**
**Ausstellungsdatum / Date of issue**

0010 -- 60360848 002

10.09.2020

**27 x 27 E**    **B → 564 mm**    **T ↗ 572 mm**
 459 x 459 mm

<b>H ↑</b>	<b>Anzahl Schubladen mm</b>	<b>75</b>	<b>KEY Lock</b>	<b>Art.-Nr.</b>
283	2: 1 x 50 / 1 x 150	75	KEY Lock	78.461.XXX
283	2: 2 x 100	75	KEY Lock	78.463.XXX
283	3: 2 x 50 / 1 x 100	75	KEY Lock	78.465.XXX
383	2: 1 x 100 / 1 x 200	75	KEY Lock	78.467.XXX
383	3: 1 x 50 / 1 x 100 / 1 x 150	75	KEY Lock	78.469.XXX
383	4: 1 x 50 / 2 x 75 / 1 x 100	75	KEY Lock	78.471.XXX
700	6: 1 x 50 / 2 x 75 / 2 x 100 / 1 x 200	75	KEY Lock	78.486.XXX
800	4: 2 x 100 / 1 x 200 / 1 x 300	75	KEY Lock	78.289.XXX
800	5: 1 x 50 / 2 x 100 / 1 x 150 / 1 x 300	75	KEY Lock	78.882.XXX
850	4: 1 x 100 / 1 x 150 / 1 x 200 / 1 x 300	75	KEY Lock	79.380.XXX
850	5: 1 x 100 / 3 x 150 / 1 x 200	75	KEY Lock	14.256.XXX
850	6: 2 x 75 / 2 x 100 / 2 x 200	75	KEY Lock	14.258.XXX
850	6: 1 x 50 / 2 x 100 / 2 x 150 / 1 x 200	75	KEY Lock	78.953.XXX
850	7: 2 x 75 / 3 x 100 / 2 x 150	75	KEY Lock	14.252.XXX
850	8: 1 x 50 / 2 x 75 / 4 x 100 / 1 x 150	75	KEY Lock	14.250.XXX
723	4: 1 x 50 / 1 x 75 / 1 x 125 / 1 x 200	75	KEY Lock	78.489.XXX
723	5: 1 x 50 / 2 x 75 / 1 x 100 / 1 x 150	75	KEY Lock	78.491.XXX
840	6: 2 x 50 / 2 x 75 / 2 x 150	75	KEY Lock	78.493.XXX
890	5: 4 x 100 / 1 x 200	75	KEY Lock	14.249.XXX
890	6: 1 x 50 / 2 x 75 / 2 x 100 / 1 x 200	75	KEY Lock	14.247.XXX
890	6: 2 x 75 / 3 x 100 / 1 x 150	75	KEY Lock	14.245.XXX

[www.lista.com](http://www.lista.com)

Farb-Informationen vgl. Ausklappseite. Bei Bestellung den gewünschten dreistelligen Farbcode (anstelle XXX) einsetzen.

**Anlage / Appendix 1 zu / to**
**Zertifikat / Certificate**
**Blatt / Page**
**60151564**
**0001**
**Ihr Zeichen / Client Reference**
**Unser Zeichen / Our Reference**
**Ausstellungsdatum / Date of issue**

0010 -- 60360848 002

10.09.2020

**36 × 27 E**
**B → 717 mm**
**T ↗ 572 mm**
 612 × 459 mm

<b>H ↑</b>	<b>Anzahl Schubladen mm</b>	<b>kg</b>	<b>KEY Lock</b>	<b>Art.-Nr.</b>
700	5: 1×50 / 2×100 / 1×150 / 1×200	75	KEY Lock	78.556.XXX
700	5: 2×75 / 2×100 / 1×250	75	KEY Lock	78.560.XXX
700	6: 2×75 / 3×100 / 1×150	75	KEY Lock	78.564.XXX
850	7: 1×50 / 2×75 / 2×100 / 1×150 / 1×200	75	KEY Lock	78.568.XXX
850	7: 2×75 / 2×100 / 2×125 / 1×150	75	KEY Lock	78.572.XXX
850	8: 4×75 / 3×100 / 1×150	75	KEY Lock	78.576.XXX
1000	7: 1×50 / 2×75 / 2×100 / 1×200 / 1×300	75	KEY Lock	78.580.XXX
1000	7: 2×75 / 1×100 / 3×150 / 1×200	75	KEY Lock	78.584.XXX
1000	8: 1×50 / 2×75 / 3×100 / 1×150 / 1×250	75	KEY Lock	78.588.XXX
962	5: 1×50 / 2×100 / 1×150 / 1×200	75	KEY Lock	78.604.XXX
962	5: 2×75 / 2×100 / 1×250	75	KEY Lock	78.608.XXX
962	6: 2×75 / 3×100 / 1×150	75	KEY Lock	78.606.XXX

# Anlage / Appendix 1 zu / to

Zertifikat / Certificate  
**60151564**

Blatt / Page  
**0001**

Ihr Zeichen / Client Reference

Unser Zeichen / Our Reference

Ausstellungsdatum / Date of issue

0010 -- 60360848 002

10.09.2020





**54 x 27 E**

**B → 1023 mm**

**T ↗ 572 mm**

 918 x 459 mm



 H ↑	Anzahl Schubladen mm			Art.-Nr. 
850	5: 3×100 / 1×150 / 1×300**	75	KEY Lock	<b>78.742.XXX</b>
850	5: 3×100 / 1×150 / 1×300	200	KEY Lock	<b>78.744.XXX</b>
850	6: 2×75 / 2×100 / 1×150 / 1×250**	75	KEY Lock	<b>78.746.XXX</b>
850	6: 2×75 / 2×100 / 1×150 / 1×250	200	KEY Lock	<b>78.748.XXX</b>
850	7: 1×50 / 2×75 / 2×100 / 1×150 / 1×200	75	KEY Lock	<b>78.750.XXX</b>
850	7: 1×50* / 2×75 / 2×100 / 1×150 / 1×200	200	KEY Lock	<b>78.752.XXX</b>
1000	6: 3×100 / 2×150 / 1×300**	75	KEY Lock	<b>78.754.XXX</b>
1000	6: 3×100 / 2×150 / 1×300	200	KEY Lock	<b>78.756.XXX</b>
1000	7: 2×75 / 1×100 / 3×150 / 1×200	75	KEY Lock	<b>78.758.XXX</b>
1000	7: 2×75 / 1×100 / 3×150 / 1×200	200	KEY Lock	<b>78.760.XXX</b>
1000	8: 2×75 / 4×100 / 1×150 / 1×200	75	KEY Lock	<b>78.762.XXX</b>
1000	8: 2×75 / 4×100 / 1×150 / 1×200	200	KEY Lock	<b>78.764.XXX</b>
1450	9: 2×75 / 2×100 / 2×150 / 2×200 / 1×300**	75	KEY Lock	<b>78.766.XXX</b>
1450	9: 2×75 / 2×100 / 2×150 / 2×200 / 1×300	200	KEY Lock	<b>78.768.XXX</b>
1450	10: 2×75 / 3×100 / 2×150 / 3×200	75	KEY Lock	<b>78.770.XXX</b>
1450	10: 2×75 / 3×100 / 2×150 / 3×200	200	KEY Lock	<b>78.772.XXX</b>
1450	11: 2×75 / 5×100 / 2×150 / 2×200	75	KEY Lock	<b>78.774.XXX</b>
1450	11: 2×75 / 5×100 / 2×150 / 2×200	200	KEY Lock	<b>78.776.XXX</b>
962	4: 1×100 / 2×150 / 1×200	75	KEY Lock	<b>78.778.XXX</b>
962	5: 2×75 / 1×100 / 1×150 / 1×200	75	KEY Lock	<b>78.780.XXX</b>
962	6: 2×75 / 3×100 / 1×150	75	KEY Lock	<b>78.782.XXX</b>

**Anlage / Appendix 1 zu / to**

Zertifikat / Certificate  
**60151564**

Blatt / Page  
**0001**

Ihr Zeichen / Client Reference

Unser Zeichen / Our Reference

Ausstellungsdatum / Date of issue

0010 - - 60360848 002

10.09.2020

**18 x 36 E**

**B → 411 mm**

**T ↗ 725 mm**

 306 x 612 mm



<b>H ↑</b>	Anzahl Schubladen mm	<b>kg</b>	<b>Lock</b>	Art.-Nr. 
283	2: 1 x 50 / 1 x 150	75	KEY Lock	78.431.XXX
283	2: 2 x 100	75	KEY Lock	78.433.XXX
283	3: 1 x 50 / 2 x 75	75	KEY Lock	78.435.XXX
383	3: 2 x 75 / 1 x 150	75	KEY Lock	78.437.XXX
383	3: 1 x 50 / 1 x 100 / 1 x 150	75	KEY Lock	78.439.XXX
383	4: 1 x 50 / 2 x 75 / 1 x 100	75	KEY Lock	78.441.XXX
700	3: 2 x 150 / 1 x 300	75	KEY Lock	78.447.XXX
700	5: 2 x 75 / 3 x 150	75	KEY Lock	78.449.XXX
723	4: 1 x 50 / 1 x 100 / 2 x 150	75	KEY Lock	78.453.XXX
723	5: 2 x 50 / 2 x 100 / 1 x 150	75	KEY Lock	78.455.XXX
840	6: 2 x 50 / 2 x 75 / 2 x 150	75	KEY Lock	78.457.XXX
890	5: 2 x 75 / 3 x 150	75	KEY Lock	78.459.XXX

# Anlage / Appendix 1 zu / to

Zertifikat / Certificate  
60151564

Blatt / Page  
0001

Ihr Zeichen / Client Reference

Unser Zeichen / Our Reference

Ausstellungsdatum / Date of issue

0010 - - 60360848 002

10.09.2020

**27 x 36 E**      **B → 564 mm**      **T ↗ 725 mm**

 459 x 612 mm

**H ↑** Anzahl Schubladen mm

  Art.-Nr. 



283	2: 1x50 / 1x150	75	KEY Lock	78.497.XXX
283	2: 2x100	75	KEY Lock	78.499.XXX



383	3: 1x50 / 1x100 / 1x150	75	KEY Lock	14.437.XXX
383	3: 2x75 / 1x150	75	KEY Lock	78.505.XXX



533	4: 1x50 / 2x100 / 1x200	75	KEY Lock	15.009.XXX
533	5: 1x50 / 2x75 / 1x100 / 1x150	75	KEY Lock	78.511.XXX



700	5: 2x75 / 1x100 / 1x150 / 1x200	75	KEY Lock	78.518.XXX
700	4: 1x100 / 2x150 / 1x200	75	KEY Lock	14.350.XXX
700	6: 1x50 / 2x75 / 2x100 / 1x200	75	KEY Lock	14.352.XXX



800	4: 2x100 / 1x200 / 1x300	75	KEY Lock	14.371.XXX
800	5: 1x50 / 2x100 / 1x150 / 1x300	75	KEY Lock	14.368.XXX
800	6: 2x75 / 2x100 / 1x150 / 1x200	75	KEY Lock	78.522.XXX
800	7: 1x50 / 2x75 / 2x100 / 2x150	75	KEY Lock	14.354.XXX
800	7: 2x75 / 4x100 / 1x150	75	KEY Lock	14.367.XXX



800	1: 1x100 + 1 Tür 600, rechts / 1 Verstellboden / 1 Auszugboden	75	KEY Lock	78.524.XXX
-----	--	----	----------	------------



850	4: 3x150 / 1x300	75	KEY Lock	78.525.XXX
850	5: 1x50 / 2x100 / 1x200 / 1x300	75	KEY Lock	78.527.XXX
850	6: 1x75 / 3x100 / 1x125 / 1x250	75	KEY Lock	78.529.XXX
850	5: 2x100 / 1x150 / 2x200	75	KEY Lock	14.399.XXX
850	6: 1x50 / 2x100 / 2x150 / 1x200	75	KEY Lock	14.407.XXX
850	7: 1x50 / 2x75 / 2x100 / 1x150 / 1x200	75	KEY Lock	14.404.XXX
850	7: 2x75 / 3x100 / 2x150	75	KEY Lock	14.405.XXX
850	8: 1x50 / 2x75 / 4x100 / 1x150	75	KEY Lock	14.403.XXX

**Anlage / Appendix 1 zu / to**

Zertifikat / Certificate  
**60151564**

Blatt / Page  
**0001**

Ihr Zeichen / Client Reference

Unser Zeichen / Our Reference

Ausstellungsdatum / Date of issue

0010 -- 60360848 002

10.09.2020

**27 x 36 E**

**B** → 564 mm

**T** ↗ 725 mm

 459 x 612 mm



**H** ↑ Anzahl Schubladen mm

 kg



Art.-Nr. 

**723** 4: 1 x 50 / 2 x 100 / 1 x 200

75

KEY Lock

**14.281.XXX**

**723** 5: 2 x 50 / 2 x 100 / 1 x 150

75

KEY Lock

**14.331.XXX**

**723** 6: 2 x 50 / 2 x 75 / 2 x 100

75

KEY Lock

**14.347.XXX**

**890** 5: 2 x 75 / 1 x 100 / 1 x 150 / 1 x 200

75

KEY Lock

**78.546.XXX**

**890** 6: 1 x 50 / 2 x 75 / 2 x 100 / 1 x 200

75

KEY Lock

**78.548.XXX**

**990** 5: 1 x 50 / 2 x 100 / 1 x 150 / 1 x 300

75

KEY Lock

**14.374.XXX**

**990** 5: 3 x 100 / 2 x 200

75

KEY Lock

**14.397.XXX**

**990** 7: 1 x 50 / 2 x 75 / 2 x 100 / 2 x 150

75

KEY Lock

**14.372.XXX**

**990** 7: 2 x 75 / 4 x 100 / 1 x 150

75

KEY Lock

**14.373.XXX**



**Anlage / Appendix 1 zu / to**
**Zertifikat / Certificate**
**Blatt / Page**
**60151564**
**0001**
**Ihr Zeichen / Client Reference**
**Unser Zeichen / Our Reference**
**Ausstellungsdatum / Date of issue**

0010 - - 60360848 002

10.09.2020

**36 × 36 E**
**B → 717 mm**
**T ↗ 725 mm**

 612 × 612 mm

**H ↑ Anzahl Schubladen mm**

800 4: 1 × 100 / 2 × 150 / 1 × 300

800 6: 2 × 75 / 2 × 100 / 1 × 150 / 1 × 200

850 4: 1 × 100 / 1 × 150 / 1 × 200 / 1 × 300

850 4: 1 × 100 / 1 × 150 / 1 × 200 / 1 × 300

850 5: 1 × 50 / 2 × 100 / 1 × 200 / 1 × 300

850 5: 1 × 50\* / 2 × 100 / 1 × 200 / 1 × 300

850 5: 1 × 100 / 3 × 150 / 1 × 200

850 5: 1 × 100 / 3 × 150 / 1 × 200

850 7: 1 × 50 / 2 × 75 / 2 × 100 / 1 × 150 / 1 × 200

850 7: 1 × 50\* / 2 × 75 / 2 × 100 / 1 × 150 / 1 × 200

850 7: 2 × 75 / 3 × 100 / 2 × 150

850 7: 2 × 75 / 3 × 100 / 2 × 150

850 8: 1 × 50 / 2 × 75 / 4 × 100 / 1 × 150

850 8: 1 × 50\* / 2 × 75 / 4 × 100 / 1 × 150

 Art.-Nr. 

 75 KEY Lock **78.632.XXX**

 75 KEY Lock **78.636.XXX**

 75 KEY Lock **79.382.XXX**

 200 KEY Lock **79.498.XXX**

 75 KEY Lock **14.411.XXX**

 200 KEY Lock **14.505.XXX**

 75 KEY Lock **14.410.XXX**

 200 KEY Lock **14.504.XXX**

 75 KEY Lock **78.640.XXX**

 200 KEY Lock **78.642.XXX**

 75 KEY Lock **14.409.XXX**

 200 KEY Lock **14.503.XXX**

 75 KEY Lock **14.408.XXX**

 200 KEY Lock **14.502.XXX**

\* Tragkraft max. 75 kg

# Anlage / Appendix 1 zu / to

Zertifikat / Certificate  
60151564

Blatt / Page  
0001

Ihr Zeichen / Client Reference

Unser Zeichen / Our Reference

Ausstellungsdatum / Date of issue



0010 - - 60360848 002

10.09.2020

**36 x 36 E**    **B** → 717 mm    **T** ↗ 725 mm

 612 x 612 mm



H ↑	Anzahl Schubladen mm			Art.-Nr. 
1000	6: 1 x 50/3 x 150/2 x 200	75	KEY Lock	14.417.XXX
1000	6: 1 x 50*/3 x 150/2 x 200	200	KEY Lock	14.510.XXX
1000	6: 1 x 100/4 x 150/1 x 200	75	KEY Lock	14.415.XXX
1000	6: 1 x 100/4 x 150/1 x 200	200	KEY Lock	14.509.XXX
1000	7: 1 x 50/2 x 75/2 x 100/1 x 200/1 x 300	75	KEY Lock	14.416.XXX
1000	7: 1 x 50*/2 x 75/2 x 100/1 x 200/1 x 300	200	KEY Lock	18.205.XXX
1000	8: 1 x 50/2 x 75/2 x 100/2 x 150/1 x 200	75	KEY Lock	14.414.XXX
1000	8: 1 x 50*/2 x 75/2 x 100/2 x 150/1 x 200	200	KEY Lock	14.508.XXX
1000	8: 2 x 75/3 x 100/3 x 150	75	KEY Lock	14.412.XXX
1000	8: 2 x 75/3 x 100/3 x 150	200	KEY Lock	14.506.XXX
1000	9: 9 x 100	75	KEY Lock	78.648.XXX
1000	9: 9 x 100	200	KEY Lock	78.650.XXX
1000	10: 1 x 50/2 x 75/7 x 100	75	KEY Lock	14.413.XXX
1000	10: 1 x 50*/2 x 75/7 x 100	200	KEY Lock	14.507.XXX
1450	9: 2 x 75/2 x 100/2 x 150/2 x 200/1 x 300	75	KEY Lock	78.309.XXX
1450	9: 2 x 75/2 x 100/2 x 150/2 x 200/1 x 300	200	KEY Lock	14.511.XXX
1450	9: 3 x 100/5 x 150/1 x 300	75	KEY Lock	78.311.XXX
1450	9: 3 x 100/5 x 150/1 x 300	200	KEY Lock	13.106.XXX
1450	10: 1 x 50/5 x 100/4 x 200	75	KEY Lock	78.313.XXX
1450	10: 1 x 50*/5 x 100/4 x 200	200	KEY Lock	14.512.XXX
890	3: 1 x 100/1 x 200/1 x 300	200	KEY Lock	69.927.XXX
890	5: 1 x 50/2 x 100/1 x 150/1 x 200	75	KEY Lock	69.928.XXX
890	6: 2 x 75/3 x 100/1 x 150	75	KEY Lock	69.929.XXX
962	5: 1 x 50/2 x 100/1 x 150/1 x 200	75	KEY Lock	78.652.XXX
1112	7: 2 x 75/2 x 100/2 x 125/1 x 150	75	KEY Lock	78.666.XXX
1112	8: 4 x 75/3 x 100/1 x 150	75	KEY Lock	78.668.XXX

# Anlage / Appendix 1 zu / to

Zertifikat / Certificate  
60151564

Blatt / Page  
0001

Ihr Zeichen / Client Reference

Unser Zeichen / Our Reference

Ausstellungsdatum / Date of issue

0010 -- 60360848 002

10.09.2020



**45 x 36 E**

**B → 870 mm**

**T ↗ 725 mm**

 765 x 612 mm



<b>H ↑</b>	Anzahl Schubladen mm			Art.-Nr. 
850	7: 1x50/2x75/2x100/1x150/1x200	75	KEY Lock	78.686.XXX
850	7: 1x50*/2x75/2x100/1x150/1x200	200	KEY Lock	78.688.XXX
850	7: 2x75/2x100/2x125/1x150	75	KEY Lock	78.690.XXX
850	7: 2x75/2x100/2x125/1x150	200	KEY Lock	78.692.XXX
850	8: 4x75/3x100/1x150	75	KEY Lock	78.682.XXX
850	8: 4x75/3x100/1x150	200	KEY Lock	78.684.XXX
1000	7: 1x50/2x75/2x100/1x200/1x300	75	KEY Lock	78.694.XXX
1000	7: 1x50*/2x75/2x100/1x200/1x300	200	KEY Lock	78.696.XXX
1000	8: 1x50/2x75/3x100/1x150/1x250**	75	KEY Lock	78.698.XXX
1000	8: 1x50*/2x75/3x100/1x150/1x250	200	KEY Lock	78.700.XXX
1000	8: 3x50/2x75/2x100/1x150/1x250**	75	KEY Lock	78.702.XXX
1000	8: 3x50*/2x75/2x100/1x150/1x250	200	KEY Lock	78.704.XXX
1450	9: 3x100/5x150/1x300**	75	KEY Lock	78.706.XXX
1450	9: 3x100/5x150/1x300	200	KEY Lock	78.708.XXX
1450	9: 9x150	75	KEY Lock	78.710.XXX
1450	9: 9x150	200	KEY Lock	78.712.XXX
1450	13: 4x75/6x100/3x150	75	KEY Lock	78.714.XXX
1450	13: 4x75/6x100/3x150	200	KEY Lock	78.716.XXX

\* Tragkraft max. 75 kg

\*\* Tragkraft 200 kg

# Anlage / Appendix 1 zu / to

Zertifikat / Certificate

Blatt / Page

60151564

0001

Ihr Zeichen / Client Reference

Unser Zeichen / Our Reference

Ausstellungsdatum / Date of issue

0010 -- 60360848 002

10.09.2020





**54 x 36 E**

**B → 1023 mm**

**T ↗ 725 mm**

 918 x 612 mm





 H ↑	Anzahl Schubladen mm			Art.-Nr. 
850	5: 3 x 100 / 1 x 150 / 1 x 300**	75	KEY Lock	78.796.XXX
850	5: 3 x 100 / 1 x 150 / 1 x 300	200	KEY Lock	78.798.XXX
850	6: 2 x 75 / 2 x 100 / 1 x 150 / 1 x 250**	75	KEY Lock	78.800.XXX
850	6: 2 x 75 / 2 x 100 / 1 x 150 / 1 x 250	200	KEY Lock	78.802.XXX
850	7: 1 x 50 / 2 x 75 / 2 x 100 / 1 x 150 / 1 x 200	75	KEY Lock	78.804.XXX
850	7: 1 x 50* / 2 x 75 / 2 x 100 / 1 x 150 / 1 x 200	200	KEY Lock	78.806.XXX
1000	5: 2 x 100 / 2 x 200 / 1 x 300**	75	KEY Lock	79.390.XXX
1000	5: 2 x 100 / 2 x 200 / 1 x 300	200	KEY Lock	79.392.XXX
1000	6: 1 x 100 / 4 x 150 / 1 x 200	75	KEY Lock	78.291.XXX
1000	6: 1 x 100 / 4 x 150 / 1 x 200	200	KEY Lock	14.515.XXX
1000	7: 1 x 50 / 2 x 75 / 2 x 100 / 1 x 200 / 1 x 300**	75	KEY Lock	78.292.XXX
1000	7: 1 x 50* / 2 x 75 / 2 x 100 / 1 x 200 / 1 x 300	200	KEY Lock	14.516.XXX
1000	8: 1 x 50 / 2 x 75 / 2 x 100 / 2 x 150 / 1 x 200	75	KEY Lock	78.293.XXX
1000	8: 1 x 50* / 2 x 75 / 2 x 100 / 2 x 150 / 1 x 200	200	KEY Lock	12.541.XXX
1000	8: 2 x 75 / 3 x 100 / 3 x 150	75	KEY Lock	78.294.XXX
1000	8: 2 x 75 / 3 x 100 / 3 x 150	200	KEY Lock	14.513.XXX
1000	10: 1 x 50 / 2 x 75 / 7 x 100	75	KEY Lock	78.295.XXX
1000	10: 1 x 50* / 2 x 75 / 7 x 100	200	KEY Lock	14.514.XXX
1450	9: 2 x 75 / 2 x 100 / 2 x 150 / 2 x 200 / 1 x 300**	75	KEY Lock	78.296.XXX
1450	9: 2 x 75 / 2 x 100 / 2 x 150 / 2 x 200 / 1 x 300	200	KEY Lock	12.550.XXX
1450	9: 3 x 100 / 5 x 150 / 1 x 300**	75	KEY Lock	78.297.XXX
1450	9: 3 x 100 / 5 x 150 / 1 x 300	200	KEY Lock	14.518.XXX
1450	10: 1 x 50 / 5 x 100 / 4 x 200	75	KEY Lock	78.298.XXX
1450	10: 1 x 50* / 5 x 100 / 4 x 200	200	KEY Lock	14.519.XXX

**Anlage / Appendix 1 zu / to**
**Zertifikat / Certificate**  
**60151564**
**Blatt / Page**  
**0001**
**Ihr Zeichen / Client Reference**
**Unser Zeichen / Our Reference**
**Ausstellungsdatum / Date of issue**

0010 - - 60360848 002

10.09.2020

**64 x 36 E**
**B → 1193 mm**
**T ↗ 725 mm**
 1088 x 612 mm





	<b>H ↑</b>	Anzahl Schubladen mm			Art.-Nr. 
<b>1000</b>	7:	2 x 75/2 x 100/1 x 150**/2 x 200**	75	KEY Lock	<b>78.826.XXX</b>
<b>1000</b>	7:	2 x 75/2 x 100/1 x 150/2 x 200	200	KEY Lock	<b>78.828.XXX</b>
<b>1000</b>	8:	2 x 75/4 x 100/1 x 150**/1 x 200**	75	KEY Lock	<b>78.830.XXX</b>
<b>1000</b>	8:	2 x 75/4 x 100/1 x 150/1 x 200	200	KEY Lock	<b>78.832.XXX</b>
<b>1000</b>	8:	2 x 75/3 x 100/3 x 150**	75	KEY Lock	<b>78.834.XXX</b>
<b>1000</b>	8:	2 x 75/3 x 100/3 x 150	200	KEY Lock	<b>78.836.XXX</b>

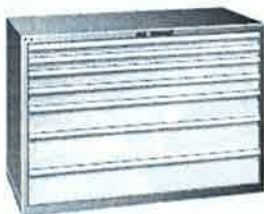

<b>1450</b>	<b>10:</b>	2 x 150/1 x 125/1 x 75/ 3 x 100/1 x 150/2 x 200	200	KEY Lock	<b>78.838.XXX</b>
<b>1450</b>	<b>11:</b>	1 x 150/1 x 125/1 x 75/ 5 x 100/2 x 150/1 x 200	200	KEY Lock	<b>78.840.XXX</b>
<b>1450</b>	<b>12:</b>	1 x 150/1 x 125/3 x 75/ 5 x 100/1 x 150/1 x 200	200	KEY Lock	<b>78.842.XXX</b>

\*\* Tragkraft 200 kg

**78 x 36 E**
**B → 1431 mm**
**T ↗ 725 mm**
 1326 x 612 mm

	<b>H ↑</b>	Anzahl Schubladen mm			Art.-Nr. 
<b>1000</b>	5:	2 x 100/2 x 200**/1 x 300**	75	KEY Lock	<b>79.492.XXX</b>
<b>1000</b>	5:	2 x 100/2 x 200/1 x 300	200	KEY Lock	<b>79.494.XXX</b>
<b>1000</b>	7:	2 x 75/2 x 100/1 x 150**/2 x 200**	75	KEY Lock	<b>78.856.XXX</b>
<b>1000</b>	7:	2 x 75/2 x 100/1 x 150/2 x 200	200	KEY Lock	<b>78.858.XXX</b>
<b>1000</b>	8:	2 x 75/4 x 100/1 x 150**/1 x 200**	75	KEY Lock	<b>78.860.XXX</b>
<b>1000</b>	8:	2 x 75/4 x 100/1 x 150/1 x 200	200	KEY Lock	<b>78.862.XXX</b>



<b>1450</b>	<b>10:</b>	2 x 150/1 x 125/1 x 75/ 3 x 100/1 x 150/2 x 200	200	KEY Lock	<b>78.868.XXX</b>
<b>1450</b>	<b>11:</b>	1 x 150/1 x 125/1 x 75/ 5 x 100/2 x 150/1 x 200	200	KEY Lock	<b>78.870.XXX</b>
<b>1450</b>	<b>12:</b>	1 x 150/1 x 125/3 x 75/ 5 x 100/1 x 150/1 x 200	200	KEY Lock	<b>78.872.XXX</b>

# Anlage / Appendix 1 zu / to

Zertifikat / Certificate

Blatt / Page

60151564

0001

Ihr Zeichen / Client Reference

Unser Zeichen / Our Reference

Ausstellungsdatum / Date of issue

0010 - - 60360848 002

10.09.2020

**Tiefe 27 E**

LISTA-Türhaken		18 x 27 E	27 x 27 E	36 x 27 E	54 x 27 E
					
Schrank-Grundfläche mm		411 x 572 mm	564 x 572 mm	717 x 572 mm	1023 x 572 mm
					
	Lichte Höhe mm	Art.-Nr. 	Art.-Nr. 	Art.-Nr. 	Art.-Nr. 
283	200	71.059.XXX	71.070.XXX		
383	300	71.060.XXX	71.071.XXX		
533	450	71.061.XXX	71.072.XXX		
650	550	71.062.XXX	71.073.XXX		
700	600	71.063.XXX	71.074.XXX	71.086.XXX	71.102.XXX
800	700		71.075.XXX		
850	750	71.401.XXX	71.076.XXX	71.087.XXX	71.103.XXX
1000	900	71.064.XXX	71.077.XXX	71.088.XXX	71.104.XXX
1150	1050				
1325	1225				
1450	1350			71.089.XXX	71.105.XXX
1625	1525				

 = auf Anfrage

LISTA-Einbautür		18 x 27 E	27 x 27 E	36 x 27 E	54 x 27 E
					
75 kg Tragkraft					
Schubladen-Nutzfläche mm		306 x 459 mm	459 x 459 mm	612 x 459 mm	918 x 459 mm
					
	Nutz-Höhe mm	Art.-Nr. 	Art.-Nr. 	Art.-Nr. 	Art.-Nr. 
50*	32,5 28,5	72.000.XXX	72.012.XXX	72.042.XXX	72.080.XXX
75	57,5 49	72.001.XXX	72.013.XXX	72.043.XXX	72.505.XXX
100	82,5 76	72.002.XXX	72.015.XXX	72.045.XXX	72.506.XXX
125	107,5 76	-	72.017.XXX	72.047.XXX	72.507.XXX
150	132,5 126	72.003.XXX	72.019.XXX	72.049.XXX	72.508.XXX
200	182,5 176	72.004.XXX	72.021.XXX	72.051.XXX	72.509.XXX
250	232,5 226	-	72.023.XXX	72.053.XXX	-
300	282,5 276	72.005.XXX	72.025.XXX	72.055.XXX	-
* Schubladen mit 50 mm Fronthöhe müssen an oberster Position platziert werden					
					
200 kg Tragkraft					
75	57,5 49	-	72.014.XXX	72.044.XXX	72.081.XXX
100	82,5 76	-	72.016.XXX	72.046.XXX	72.082.XXX
125	107,5 76	-	72.018.XXX	72.048.XXX	72.083.XXX
150	132,5 126	-	72.020.XXX	72.050.XXX	72.084.XXX
200	182,5 176	-	72.022.XXX	72.052.XXX	72.085.XXX
250	232,5 226	-	72.024.XXX	72.054.XXX	72.086.XXX
300	282,5 276	-	72.026.XXX	72.056.XXX	72.087.XXX

# Anlage / Appendix 1 zu / to

Zertifikat / Certificate  
**60151564**

Blatt / Page  
**0001**

Ihr Zeichen / Client Reference















Unser Zeichen / Our Reference















Ausstellungsdatum / Date of issue

0010 - - 60360848 002

10.09.2020

Tiefe 36 E

18 x 36 E	27 x 36 E	36 x 36 E	45 x 36 E	54 x 36 E	64 x 36 E	78 x 36 E
						
411 x 725 mm	564 x 725 mm	717 x 725 mm	870 x 725 mm	1023 x 725 mm	1193 x 725 mm	1431 x 725 mm
Art.-Nr. 	Art.-Nr. 	Art.-Nr. 	Art.-Nr. 	Art.-Nr. 	Art.-Nr. 	Art.-Nr. 
71.065.XXX	71.078.XXX					
71.066.XXX	71.079.XXX					
71.067.XXX	71.080.XXX					
71.068.XXX	71.081.XXX					
71.069.XXX	71.082.XXX	71.090.XXX	71.098.XXX	71.106.XXX	71.110.XXX	71.114.XXX
	71.083.XXX	71.091.XXX				
71.407.XXX	71.084.XXX	71.092.XXX	71.099.XXX	71.107.XXX	71.416.XXX	71.421.XXX
71.408.XXX	71.085.XXX	71.093.XXX	71.100.XXX	71.108.XXX	71.111.XXX	71.115.XXX
		71.094.XXX				
		71.095.XXX			71.112.XXX	71.116.XXX
		71.096.XXX	71.101.XXX	71.109.XXX	71.113.XXX	71.117.XXX
		71.097.XXX				

18 x 36 E	27 x 36 E	36 x 36 E	45 x 36 E	54 x 36 E	64 x 36 E	78 x 36 E
						
306 x 612 mm	459 x 612 mm	612 x 612 mm	765 x 612 mm	918 x 612 mm	1088 x 612 mm	1326 x 612 mm
Art.-Nr. 	Art.-Nr. 	Art.-Nr. 	Art.-Nr. 	Art.-Nr. 	Art.-Nr. 	Art.-Nr. 
72.006.XXX	72.027.XXX	72.057.XXX	72.072.XXX	72.088.XXX	72.805.XXX	72.806.XXX
72.007.XXX	72.028.XXX	72.058.XXX	72.540.XXX	72.510.XXX	72.515.XXX	72.517.XXX
72.008.XXX	72.030.XXX	72.060.XXX	72.541.XXX	72.511.XXX	72.516.XXX	72.518.XXX
	72.032.XXX	72.062.XXX	72.542.XXX	72.512.XXX		
72.009.XXX	72.034.XXX	72.064.XXX	72.543.XXX	72.513.XXX		
72.010.XXX	72.036.XXX	72.066.XXX	72.544.XXX	72.514.XXX		
	72.038.XXX	72.068.XXX				
72.011.XXX	72.040.XXX	72.070.XXX				
	72.029.XXX	72.059.XXX	72.073.XXX	72.089.XXX	72.096.XXX	72.103.XXX
	72.031.XXX	72.061.XXX	72.074.XXX	72.090.XXX	72.097.XXX	72.104.XXX
	72.033.XXX	72.063.XXX	72.075.XXX	72.091.XXX	72.098.XXX	72.105.XXX
	72.035.XXX	72.065.XXX	72.076.XXX	72.092.XXX	72.099.XXX	72.106.XXX
	72.037.XXX	72.067.XXX	72.077.XXX	72.093.XXX	72.100.XXX	72.107.XXX
	72.039.XXX	72.069.XXX	72.078.XXX	72.094.XXX	72.101.XXX	72.108.XXX
	72.041.XXX	72.071.XXX	72.079.XXX	72.095.XXX	72.102.XXX	72.109.XXX

Zertifikat / Certificate

Blatt / Page

60151564

0001

Ihr Zeichen / Client Reference

Unser Zeichen / Our Reference

Ausstellungsdatum / Date of issue

0010 - - 60360848 002

10.09.2020



### Flügeltüren innenliegend für Auszug- und Verstellböden

Aus Stahlblech, als frontseitiger Abschluss für die unterhalb der Schubladen in die Gehäuse eingebauten Auszug- und Verstellböden. Die Summe von Flügeltür-Fronthöhe und allen Schubladen-Fronthöhen muss der lichten Höhe des Schrankgehäuses entsprechen.

		Tiefe 27 E	
		18 x 27 E	27 x 27 E
<b>Flügeltüren, innenliegend*</b>	Art.-Nr.	74.110.XXX	74.112.XXX
rechts angeschlagen	H 450 mm		
rechts angeschlagen	H 600 mm	74.111.XXX	74.113.XXX
rechts angeschlagen	H 750 mm	340.166.XXX	338.736.XXX
links angeschlagen	H 450 mm	74.122.XXX	74.126.XXX
links angeschlagen	H 600 mm	74.123.XXX	74.127.XXX
links angeschlagen	H 750 mm	340.999.XXX	338.737.XXX
+ Zylinder verschiedenschliessend		222.376.000	

\* ohne Zylinder, bitte separat bestellen



### Auszug- und Verstellboden für innenliegende Türen

Aus Stahlblech, Taubengrau, NCS S 4502-B, Tragkraft Auszugboden 75 kg, Verstellboden 200 kg. Durch die Teilung von jeweils 25 mm in den vertikalen Stützen der Schrankgehäuse lassen sich die Böden in beliebiger Reihenfolge in das gleiche Schrankgehäuse einbauen.

<b>Verstellboden, H 75 mm</b>	74.005.000	74.009.000
Nutzmasse (B x T mm)	390 x 465	503 x 465
<b>Auszugboden, H 100 mm</b>	74.004.000	74.008.000
Nutzmasse (B x T mm)	281 x 459	434 x 459



### Abrollrand 3-seitig und Rillenmatte

Aus Stahlblech, Schwarz, NCS S 9000-N, inklusive Rillenmatte, schwarz.

<b>Abrollrand mit Rillenmatte</b>	74.023.000	74.025.000
Masse (B x T x H mm)	411 x 572 x 20	564 x 572 x 20
<b>Rillenmatte, einzeln</b>	74.012.000	74.014.000
Masse (B x T x H mm)	406 x 567 x 2	559 x 567 x 2



### Abdeckplatte Kunstharz-beschichtet

Oberfläche und Kanten Lichtgrau, NCS S 1500-N, Dekor-Spanplatte (Güteklasse E1), mit beidseitiger Melamin-Beschichtung (gefertigt nach Norm EN 14322). Allseitig mit 2 mm starken Kunststoffkanten. Inkl. Bohrungen und Befestigungsmaterial.

<b>Abdeckplatte Kunstharz</b>	74.140.000	17.268.000
Masse (B x T x H mm)	411 x 572 x 22	564 x 572 x 22



### Abdeckplatte Multiplex

Aus gedämpften Buchenfurnieren mehrschichtig wasserfest verleimt (DIN 68 705), Kanten gebrochen, Oberfläche geschliffen, geölt und gewachst. Die Platte ist spritzwasserfest, schmutzabweisend und weitgehend unempfindlich gegen Öl und Fett. Inkl. Bohrungen und Befestigungsmaterial.

<b>Abdeckplatte Multiplex</b>	12.590.000	12.592.000
Masse (B x T x H mm)	411 x 572 x 20	564 x 572 x 20



### Gehäuse-Sockel

Aus Stahlblech, für Höhenausgleich, Schwarz, NCS S 9000-N.

<b>Gehäuse-Sockel, H 50 mm</b>	74.045.000	74.049.000
Masse (B x T mm)	411 x 540	564 x 540
<b>Gehäuse-Sockel, H 100 mm</b>	74.046.000	74.050.000
Masse (B x T mm)	411 x 540	564 x 540



### 2-Weg-Hubwagen-/Staplersockel

Aus Stahlblech, zum Verschrauben mit dem Gehäuseboden, Schwarz, NCS S 9000-N. Sockelblende einzeln als vorder- bzw. rückseitiger Abschluss aufsteckbar.

<b>Sockel, ohne Blende, H 100 mm</b>	-	-
Masse (B x T mm)	-	-
<b>Blende, einzeln, H 100 mm</b>	-	-



# Anlage / Appendix 1 zu / to

Zertifikat / Certificate

Blatt / Page

**60151564**

**0001**

Ihr Zeichen / Client Reference

Unser Zeichen / Our Reference

Ausstellungsdatum / Date of issue

0010 -- 60360848 002

10.09.2020

Tiefe 27 E				Tiefe 36 E				
36 x 27 E	54 x 27 E	18 x 36 E	27 x 36 E	36 x 36 E	45 x 36 E	54 x 36 E	64 x 36 E	78 x 36 E
Art.-Nr.	Art.-Nr.	Art.-Nr.	Art.-Nr.	Art.-Nr.	Art.-Nr.	Art.-Nr.	Art.-Nr.	Art.-Nr.
74.128.XXX	-	74.110.XXX	74.112.XXX	74.128.XXX	-	-	-	-
74.129.XXX	-	74.111.XXX	74.113.XXX	74.129.XXX	-	-	-	-
338.735.XXX	-	340.166.XXX	338.736.XXX	340.735.XXX	-	-	-	-
74.130.XXX	-	74.122.XXX	74.126.XXX	74.130.XXX	-	-	-	-
74.131.XXX	-	74.123.XXX	74.127.XXX	74.131.XXX	-	-	-	-
340.048.XXX	-	340.999.XXX	338.737.XXX	340.048.XXX	-	-	-	-
222.376.000	-	-	222.376.000	-	-	-	-	-
74.105.000 856 x 465	-	74.007.000 350 x 618	74.011.000 503 x 618	74.106.000 856 x 618	-	-	-	-
-	-	74.006.000 281 x 612	74.010.000 434 x 612	342.371.080 587 x 612	-	-	-	-
74.027.000 717 x 572 x 20	74.030.000 1023 x 572 x 20	74.024.000 411 x 725 x 20	74.026.000 564 x 725 x 20	74.028.000 717 x 725 x 20	74.029.000 870 x 725 x 20	74.031.000 1023 x 725 x 20	74.032.000 1193 x 725 x 20	74.033.000 1431 x 725 x 20
74.016.000 712 x 567 x 3	74.019.000 1018 x 567 x 3	74.013.000 406 x 720 x 3	74.015.000 559 x 720 x 3	74.017.000 712 x 720 x 3	74.018.000 865 x 720 x 3	74.020.000 1018 x 720 x 3	74.021.000 1188 x 720 x 3	74.022.000 1426 x 720 x 3
17.270.000 717 x 572 x 22	74.143.000 1023 x 572 x 22	74.141.000 411 x 725 x 22	17.269.000 564 x 725 x 22	17.271.000 717 x 725 x 22	74.142.000 870 x 725 x 22	74.144.000 1023 x 725 x 22	74.145.000 1193 x 725 x 22	74.146.000 1431 x 725 x 22
12.594.000 717 x 572 x 20	12.597.000 1023 x 572 x 20	12.591.000 411 x 725 x 20	12.593.000 564 x 725 x 20	12.595.000 717 x 725 x 20	12.596.000 870 x 725 x 20	12.598.000 1023 x 725 x 20	12.599.000 1193 x 725 x 20	12.600.000 1431 x 725 x 20
74.053.000 717 x 540	74.057.000 1023 x 540	74.047.000 411 x 693	74.051.000 564 x 693	74.055.000 717 x 693	74.056.000 870 x 693	74.058.000 1023 x 693	74.059.000 1193 x 693	74.060.000 1431 x 693
74.054.000 717 x 540	-	74.048.000 411 x 693	74.052.000 564 x 693	-	-	-	-	-
74.061.000 717 x 506	74.064.000 1023 x 506	-	74.410.000 564 x 659	74.062.000 717 x 659	74.063.000 870 x 659	74.065.000 1023 x 659	74.065.000 1193 x 659	74.065.000 1431 x 659
74.066.000	74.068.000	-	74.411.000	74.066.000	74.067.000	74.068.000	74.069.000	74.070.000



# Anlage / Appendix 1 zu / to

Zertifikat / Certificate

Blatt / Page

60151564

0001

Ihr Zeichen / Client Reference

Unser Zeichen / Our Reference

Ausstellungsdatum / Date of issue

0010 - - 60360848 002

10.09.2020



**Abrollrand 4-seitig mit Schiebestange**  
Aus Stahlblech, Schwarz, NCS 5 9000-N, inklusive Rillennatte, schwarz. Schiebestange bestehend aus Griffschenkelpaar in Kunststoff, RAL 9006 weissaluminium, und Alu-Rohr Ø 25 mm, farblos eloxiert.

LISTA-Produkte

Tiefe 27 E

18 x 27 E

27 x 27 E

Art.-Nr.

Art.-Nr.

Abrollrand, H 53 mm  
Nutsche (8 x 1 mm)  
Fahrtrichtung

74.034.000  
411 x 572  
längs

74.036.000  
564 x 572  
längs



**Rollenträgerpaare**  
Satz bestehend aus je 2 Lenkrollen mit Feststellern und 2 Bockrollen. Rollenträger sandzimerverzinkt. Nylonrollen schwarz, Gummirollen grau.

mit Nylonrollen\*, Ø 100 mm  
H/Tragkraft kg  
Fahrtrichtung

74.071.000  
137/400  
längs

74.071.000  
137/400  
längs

mit Gummirollen\* Ø 100 mm  
H/Tragkraft kg  
Fahrtrichtung

74.072.000  
137/400  
längs

74.072.000  
137/400  
längs

**!** **Fahrbare Schubladenschränke müssen aus Sicherheitsgründen eine Schieb- stange sowie eine Schubladen-Einzel- sicherung besitzen.**

mit Gummirollen\*, Ø 160 mm  
H/Tragkraft kg  
Fahrtrichtung

-  
203/600  
längs

74.075.000  
203/600  
längs



**Schutzleiste**  
Aus PE schwarz, inkl. Befestigungsschrauben, Montage erfolgt an den Flanken des Schubladenschrankes. Es sind zwei Schutzleisten pro Flanke zu befestigen.

Schutzleiste  
Länge (mm)

333.888.000  
567



**Nivellierfuss Set**  
Set bestehend aus 4 Kunststoff-Gelenkfüssen, Ø 50 mm, inkl. Montageplatten und Befestigungsschrauben. Verstellbereich: 45–90 mm. Tragkraft: 1200 kg/ Fuss  
Art.-Nr. 69.919.000

**Anlage / Appendix 1 zu / to**

**Zertifikat / Certificate**

**Blatt / Page**

**60151564**

**0001**

**Ihr Zeichen / Client Reference**

**Unser Zeichen / Our Reference**

**Ausstellungsdatum / Date of issue**

0010 - - 60360848 002

10.09.2020

Tiefe 27 E				Tiefe 36 E				
36×27 E	54×27 E	18×36 E	27×36 E	36×36 E	45×36 E	54×36 E	64×36 E	78×36 E
Art.-Nr.	Art.-Nr.	Art.-Nr.	Art.-Nr.	Art.-Nr.	Art.-Nr.	Art.-Nr.	Art.-Nr.	Art.-Nr.
74.038.000 717 × 572 quer	74.041.000 1023 × 572 quer	74.035.000 411 × 725 längs	74.037.000 554 × 725 längs	74.039.000 717 × 725 längs	74.040.000 870 × 725 quer	74.042.000 1023 × 725 quer	74.043.000 1193 × 725 quer	74.044.000 1431 × 725 quer
74.077.000 137 / 400 quer	74.077.000 137 / 400 quer	74.073.000 137 / 400 längs	74.073.000 137 / 400 längs	74.073.000 137 / 400 längs	74.080.000 137 / 400 quer	74.080.000 137 / 400 quer	74.080.000 137 / 400 quer	74.080.000 137 / 400 quer
74.078.000 137 / 400 quer	74.078.000 137 / 400 quer	74.074.000 137 / 400 längs	74.074.000 137 / 400 längs	74.074.000 137 / 400 längs	74.081.000 137 / 400 quer	74.081.000 137 / 400 quer	74.081.000 137 / 400 quer	74.081.000 137 / 400 quer
74.079.000 209 / 600 quer	74.079.000 209 / 600 quer		74.076.000 209 / 600 längs	74.076.000 209 / 600 längs	74.082.000 209 / 600 quer	74.082.000 209 / 600 quer	74.082.000 209 / 600 quer	74.082.000 209 / 600 quer
333.888.000 567					323.434.000 720			



**Anlage / Appendix 1 zu / to**
**Zertifikat / Certificate**
**Blatt / Page**
**60151564**
**0001**
**Ihr Zeichen / Client Reference**
**Unser Zeichen / Our Reference**
**Ausstellungsdatum / Date of issue**

0010 - - 60360848 002

10.09.2020

**T** ↗ **725 mm**
**H** ↑ **850 mm** (ohne Nivellierfüsse)

**C1 Flügeltürschrank**

 1 Verstellboden  
 4 Nivellierfüsse

Türe angeschlagen

**B** →

LISTA Einheit

 Art.-Nr. 

rechts	411 mm	<b>18 × 36 E</b>	<b>69.941.XXX</b>
links	411 mm	<b>18 × 36 E</b>	<b>69.942.XXX</b>
rechts	564 mm	<b>27 × 36 E</b>	<b>69.943.XXX</b>
links	564 mm	<b>27 × 36 E</b>	<b>69.944.XXX</b>
rechts	717 mm	<b>36 × 36 E</b>	<b>69.945.XXX</b>
links	717 mm	<b>36 × 36 E</b>	<b>69.946.XXX</b>



**C2 Entsorgungsschrank**

 Tragfähigkeit: 200 kg  
 4 Nivellierfüsse

Kapazität

**B** →

LISTA Einheit

 Art.-Nr. 

1 × 60l	411 mm	<b>18 × 36 E</b>	<b>69.937.XXX</b>
2 × 60l	564 mm	<b>27 × 36 E</b>	<b>69.938.XXX</b>
4 × 60l	1023 mm	<b>54 × 36 E</b>	<b>69.939.XXX</b>



**C5 Medienversorgungsschrank**

 1 Tropfwanne verzinkt  
 4 Nivellierfüsse

Schlauchtor

**B** →

LISTA Einheit

 Art.-Nr. 

1	411 mm	<b>18 × 36 E</b>	<b>69.930.XXX</b>
2	411 mm	<b>18 × 36 E</b>	<b>69.931.XXX</b>
2	564 mm	<b>27 × 36 E</b>	<b>69.932.XXX</b>
3	717 mm	<b>36 × 36 E</b>	<b>69.933.XXX</b>
4	1023 mm	<b>54 × 36 E</b>	<b>69.934.XXX</b>
5	1193 mm	<b>64 × 36 E</b>	<b>69.935.XXX</b>

**C6 Energimodulschrank**
**Kombination 1**

 1 × Schalter / Steckdose 230V\*  
 2 × 2 Steckdosen 230V  
 2 × 2 Netzwerkdosen RJ45  
 4 Nivellierfüsse

Typ

**B** →

LISTA Einheit

 Art.-Nr. 

CH	411 mm	<b>18 × 36 E</b>	<b>69.910.XXX</b>
D / Schuko	411 mm	<b>18 × 36 E</b>	<b>69.912.XXX</b>
F	411 mm	<b>18 × 36 E</b>	<b>69.914.XXX</b>
GB	411 mm	<b>18 × 36 E</b>	<b>69.916.XXX</b>
CH	411 mm	<b>18 × 36 E</b>	<b>69.911.XXX</b>
D / Schuko	411 mm	<b>18 × 36 E</b>	<b>69.913.XXX</b>
F	411 mm	<b>18 × 36 E</b>	<b>69.915.XXX</b>
GB	411 mm	<b>18 × 36 E</b>	<b>69.917.XXX</b>

**Kombination 2**

 1 × Schalter / Steckdose 230V\*  
 2 × 2 Steckdosen 230V  
 2 × Druckluftanschlüsse DN7  
 (Eingang: Stecknippel: DN5;  
 Ausgang: Schnelkupplung DN5)  
 4 Nivellierfüsse

**Anlage / Appendix 1 zu / to**

Zertifikat / Certificate  
**60151564**

Blatt / Page  
**0001**

Ihr Zeichen / Client Reference

Unser Zeichen / Our Reference

Ausstellungsdatum / Date of issue

0010 - - 60360848 002

10.09.2020

Schubladenschränke mit Flügel- oder Schiebetüren

**36 x 27 E**      **B → 717 mm**      **T ↗ 600 mm**

 612 x 459 mm

<b>H ↑</b> mm	Schubladen mm	Auszugböden			Art.-Nr. 
1020	1 x 75	2	75	KEY Lock	79.400.XXX
1020	1 x 75	2	200	KEY Lock	79.402.XXX
1020	2 x 75	1	75	KEY Lock	79.404.XXX
1020	2 x 75	1	200	KEY Lock	79.406.XXX
1020	3 x 75	1	75	KEY Lock	79.408.XXX
1020	3 x 75	1	200	KEY Lock	79.410.XXX
1020	3 x 75	2	75	KEY Lock	79.412.XXX
1020	3 x 75	2	200	KEY Lock	79.414.XXX
1020	4 x 75	-	75	KEY Lock	79.416.XXX
1020	4 x 75	-	200	KEY Lock	79.418.XXX
1020	5 x 75	-	75	KEY Lock	79.420.XXX
1020	5 x 75	-	200	KEY Lock	79.422.XXX

**2 x 36 x 27 E**      **B → 1430 mm**      **T ↗ 627 mm**

 612 x 459 mm

<b>H ↑</b> mm	Schubladen mm	Auszugböden			Art.-Nr. 
1020	2 x 75	6	75	KEY Lock	79.424.XXX
1020	2 x 75	6	200	KEY Lock	79.425.XXX
1020	4 x 75	2	75	KEY Lock	79.426.XXX
1020	4 x 75	2	200	KEY Lock	79.427.XXX
1020	6 x 75	2	75	KEY Lock	79.428.XXX
1020	6 x 75	2	200	KEY Lock	79.429.XXX
1020	8 x 75	-	75	KEY Lock	79.430.XXX
1020	8 x 75	-	200	KEY Lock	79.431.XXX
1020	4 x 75	4	75	KEY Lock	79.432.XXX
1020	4 x 75	4	200	KEY Lock	79.433.XXX
1020	10 x 75	-	75	KEY Lock	79.434.XXX
1020	10 x 75	-	200	KEY Lock	79.435.XXX



**Anlage / Appendix 1 zu / to**
**Zertifikat / Certificate**
**Blatt / Page**
**60151564**
**0001**
**Ihr Zeichen / Client Reference**
**Unser Zeichen / Our Reference**
**Ausstellungsdatum / Date of issue**

0010 -- 60360848 002

10.09.2020

**36 × 36 E**
**B → 717 mm**
**T ↗ 753 mm**

 612 × 612 mm



H ↑ mm	Schubladen oben mm	Schubladen mm	Auszugböden			Art.-Nr. 
1020	-	2 × 75	2	75	KEY Lock	<b>78.222.XXX</b>
1020	-	2 × 75	2	200	KEY Lock	<b>79.436.XXX</b>
1020	2 Verstellböden		2	75	KEY Lock	<b>78.220.XXX</b>
1020	2 Verstellböden		2	200	KEY Lock	<b>79.454.XXX</b>
1020	-	4 × 75	1	75	KEY Lock	<b>79.446.XXX</b>
1020	-	4 × 75	1	200	KEY Lock	<b>79.448.XXX</b>





1020	1 × 150	2 × 75	2	75	KEY Lock	<b>79.456.XXX</b>
1020	1 × 150	2 × 75	2	200	KEY Lock	<b>79.458.XXX</b>
1020	1 × 50 / 1 × 100	1 × 75 / 2 × 100	1	75	KEY Lock	<b>79.460.XXX</b>
1020	1 × 50 / 1 × 100	1 × 75 / 2 × 100	1	200	KEY Lock	<b>79.462.XXX</b>
1020	2 × 75	3 × 75	1	75	KEY Lock	<b>79.464.XXX</b>
1020	2 × 75	3 × 75	1	200	KEY Lock	<b>79.466.XXX</b>

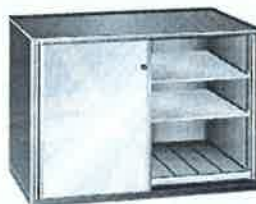

1450	-	2 × 75 / 1 × 150	2	75	KEY Lock	<b>78.256.XXX</b>
1450	-	2 × 75 / 1 × 150	2	200	KEY Lock	<b>79.468.XXX</b>
1450	3 Verstellböden		2	75	KEY Lock	<b>78.224.XXX</b>
1450	3 Verstellböden		2	200	KEY Lock	<b>79.470.XXX</b>
1450	-	2 × 75 / 3 × 150	-	75	KEY Lock	<b>79.472.XXX</b>
1450	-	2 × 75 / 3 × 150	-	200	KEY Lock	<b>79.474.XXX</b>

**2 × 36 × 36 E**
**B → 1430 mm**
**T ↗ 780 mm**

 612 × 612 mm

H ↑ mm	Schubladen mm	Auszugböden			Art.-Nr. 
1020	4 × 75	2	75	KEY Lock	<b>78.259.XXX</b>
1020	4 × 75	2	200	KEY Lock	<b>79.482.XXX</b>
1020	4 Verstellböden	2	75	KEY Lock	<b>78.258.XXX</b>
1020	4 Verstellböden	2	200	KEY Lock	<b>79.485.XXX</b>
1020	4 × 75	4	75	KEY Lock	<b>79.478.XXX</b>
1020	4 × 75	4	200	KEY Lock	<b>79.479.XXX</b>